

PRODUCT DATA SHEET

产品规格书

MODEL NAME: XC2824-H1216-AXXXX-X31



CONTENTS

| | |
|--------------------------------------|------|
| 1、Product Introduction 产品描述 | 2 |
| 2、Product Nomenclature 产品命名规则 | 2 |
| 3、Photoelectric characteristics 光电特性 | 3-4 |
| 4、Absolute Maximum Ratings 极限参数 | 4 |
| 5、Chromatic coordinates 色度坐标 | 5 |
| 6、Characteristic Curves 特性曲线图 | 6-7 |
| 7、Mechanical Dimensions 产品外观尺寸 | 8 |
| 8、Reliability Test 可靠性测试 | 8 |
| 9、Failure Criteria 失效判定标准 | 9 |
| 10、User Manuel 使用手册 | 9-11 |

1、Product Introduction 产品描述

1-1、Features 产品特征

- ◆Mechanical Dimensions 机械尺寸: 28.0x28.0x1.70 (mm)
- ◆Package Structure 封装结构: Aluminium Base Chip on Board
- ◆CRI (Ra) 显色指数: Min. 80、Min. 90、Min. 95
- ◆Nominal CCT 标称色温: 2,700K、3,000K、3,500K、4,000K、5,000K、6,000K
- ◆Chromaticity Range 色容差范围: 3-step MacAdam Ellipse
- ◆RoHS compliant 符合 RoHS 要求
- ◆Better die arrangement for optics 更好的光学设计
- ◆Wide range of luminous flux and high efficacy 高亮度、高光效



1-2、Applications 应用

- ◆Tracking Light, Spot Light, Par Light, Bulb Light, Down Light

2、Product Nomenclature 产品命名规则

XC 28 24-H 12 16-A 27 80-E 3 1

[1] [2] [3] [4] [5] [6] [7] [8] [9] [10] [11] [12]

- [1]: Company abbreviation 公司简称
- [2]: Product Size 产品尺寸
- [3]: Luminescent surface 发光面
- [4]: Optical effect level 光效等级
- [5]: Number of LED chips in Series LED 晶片串联个数
- [6]: Number of LED chips in parallel LED 晶片并联个数
- [7]: Color category 颜色类别
- [8]: Nominal CCT 标称色温
- [9]: Color index 显色指数
- [10]: Light range 光效范围
- [11]: Chromaticity Range 色容差范围
- [12]: Type of substrate 基板类型

[7]: A: Energy Star standard color temperature color 符合能源之星标准色温颜色; B: Customized color 客户定制颜色; C: Special colors (pork lamps, bread lamps, Redwood lamps, vegetable lamps, fruit lamps, seafood lamps, etc..) 特殊颜色 (猪肉灯、面包灯、红木灯、蔬菜灯、水果灯、海鲜灯等);
 [12]: 1: Mirror aluminum substrate 镜面铝基板; 2: Copper substrate 铜基板; 3: Flid-substrate 倒装基板; 4: Ceramic substrate 陶瓷基板; 5: Other substrates 其它基板.

3、Electro Optical Characteristics 光电特性

| Product Code | Nominal CCT | CRI (Ra) | | Luminous Flux (lm) | | Efficacy (lm/W) | Forward Current | Voltage (V) | | |
|--------------------------|-------------|----------|------|--------------------|-------|-----------------|-----------------|-------------|------|------|
| | | Ra | R9 | Min. | Typ. | | | Min. | Typ. | Max. |
| | | Min. | Min. | Min. | Typ. | Typ. | (mA) | Min. | Typ. | Max. |
| XC2824-H1216-A2780-E31 | 2700K | 80 | 0 | 11426 | 12027 | 139 | 2400 | 35 | 36 | 37 |
| XC2824-H1216-A2790-D31 | | 90 | 50 | 10169 | 10704 | 124 | 2400 | 35 | 36 | 37 |
| XC2824-H1216-A2795-C31 | | 95 | 90 | 9140 | 9622 | 111 | 2400 | 35 | 36 | 37 |
| XC2824-H1216-A3080-F31 | 3000K | 80 | 0 | 11902 | 12528 | 145 | 2400 | 35 | 36 | 37 |
| XC2824-H1216-A3090-D31 | | 90 | 50 | 10592 | 11150 | 129 | 2400 | 35 | 36 | 37 |
| XC2824-H1216-A3095-C31 | | 95 | 90 | 9521 | 10022 | 116 | 2400 | 35 | 36 | 37 |
| XC2824-H1216-A3580-F31 | 3500K | 80 | 0 | 12259 | 12904 | 149 | 2400 | 35 | 36 | 37 |
| XC2824-H1216-A3590-E31 | | 90 | 50 | 10910 | 11484 | 133 | 2400 | 35 | 36 | 37 |
| XC2824-H1015-A3595-D31 | | 95 | 90 | 9807 | 10323 | 119 | 2400 | 35 | 36 | 37 |
| XC2824-H1216-9-A4080-G31 | 4000K | 80 | 0 | 12378 | 13029 | 151 | 2400 | 35 | 36 | 37 |
| XC2824-H1216-A4090-E31 | | 90 | 50 | 11016 | 11596 | 134 | 2400 | 35 | 36 | 37 |
| XC2824-H1216-A4095-D31 | | 95 | 90 | 9902 | 10423 | 121 | 2400 | 35 | 36 | 37 |
| XC2824-H1216-A5080-F31 | 5000K | 80 | 0 | 12140 | 12779 | 148 | 2400 | 35 | 36 | 37 |
| XC2824-H1216-A5090-E31 | | 90 | 50 | 10804 | 11373 | 132 | 2400 | 35 | 36 | 37 |
| XC2824-H1216-A5095-C31 | | 95 | 90 | 9712 | 10223 | 118 | 2400 | 35 | 36 | 37 |

| Product Code | Nominal CCT | CRI (Ra) | | Luminous Flux (lm) | | Efficacy (lm/W) | Forward Current (mA) | Voltage (V) | | |
|------------------------|-------------|----------|------|--------------------|-------|-----------------|----------------------|-------------|------|------|
| | | Ra | R9 | Min. | Typ. | | | Min. | Typ. | Max. |
| | | Min. | Min. | Min. | Typ. | Typ. | | Min. | Typ. | Max. |
| XC2824-H1216-A6080-F31 | 6000K | 80 | 0 | 12021 | 12653 | 146 | 2400 | 35 | 36 | 37 |
| XC2824-H1216-A6090-E31 | | 90 | 50 | 10698 | 11261 | 130 | 2400 | 35 | 36 | 37 |
| XC2824-H1216-A6095-C31 | | 95 | 90 | 9616 | 10123 | 117 | 2400 | 35 | 36 | 37 |

Notes:

- 1、 a tolerance of $\pm 10\%$ on luminous flux measurements 光通量测试的公差范围为 $\pm 10\%$;
- 2、 a tolerance of $\pm 3\%$ on forward voltage measurements 电压测试的公差范围为 $\pm 3\%$;
- 3、 a tolerance of ± 1 on Ra measurements 显指测试的公差范围为 ± 1 ;
- 4、 a tolerance of ± 0.005 on CIEXY measurements CIE (X, Y) 测试的公差范围为 ± 0.005 。

4、 Absolute Maximum Ratings 极限参数

| Parameter 项目 | Symbol 符号 | Rating 参数 |
|------------------------------|-----------|--|
| Forward Current 正向电流 | I_F | 3840mA |
| Reverse Current 反向电流 | I_R | 1mA |
| Operating Temperature 工作温度 | T_{OPR} | -30°C To $+75^{\circ}\text{C}$ |
| Storage Temperature 存储温度 | T_{st} | -30°C To $+75^{\circ}\text{C}$ |
| Case Temperature 测试点温度 | T_c | 85°C |
| Junction Temperature 结温 | T_J | 120°C |
| Soldering Temperature 手工焊接温度 | T_{SOL} | $350^{\circ}\text{C} \pm 10^{\circ}\text{C}$ For 5 Seconds |
| ESD Sensitivity 防静电敏感度 | ESD | 2000V HBM |

5、Chromaticity Characteristics 色度坐标

| Color Region | Nominal CCT | Center Point (x, y) | Oval parameter | | |
|------------------------|-------------|---------------------|----------------|--------------|---------------------------------|
| | | | Major Axis a | Minor Axis b | Ellipse Rotation Angle θ |
| 3-step MacAdam ellipse | 2700K | (0.4577 , 0.4098) | 0.00774 | 0.00411 | 57.28 |
| | 3000K | (0.4339 , 0.4032) | 0.00834 | 0.00408 | 53.17 |
| | 3500K | (0.4078 , 0.3929) | 0.00951 | 0.00417 | 52.97 |
| | 4000K | (0.3818 , 0.3796) | 0.00939 | 0.00402 | 54.00 |
| | 5000K | (0.3446 , 0.3551) | 0.00822 | 0.00354 | 59.62 |
| | 6000K | (0.3228 , 0.3329) | 0.00760 | 0.00296 | 59.46 |

*. Color region stay within MacAdam 3-step ellipse from the chromaticity center.
 *. The chromaticity center refers to ANSI C78.377:2011.
 Please refer to ANSI C78.377 for the chromaticity center.
 *. θ is the angle between the major axis of the ellipse and the x-axis, and a and b are the major and minor semi-axes of an ellipse. (Ref. IEC 60081:1997 AnnexD)

X-Y chart CIE1931

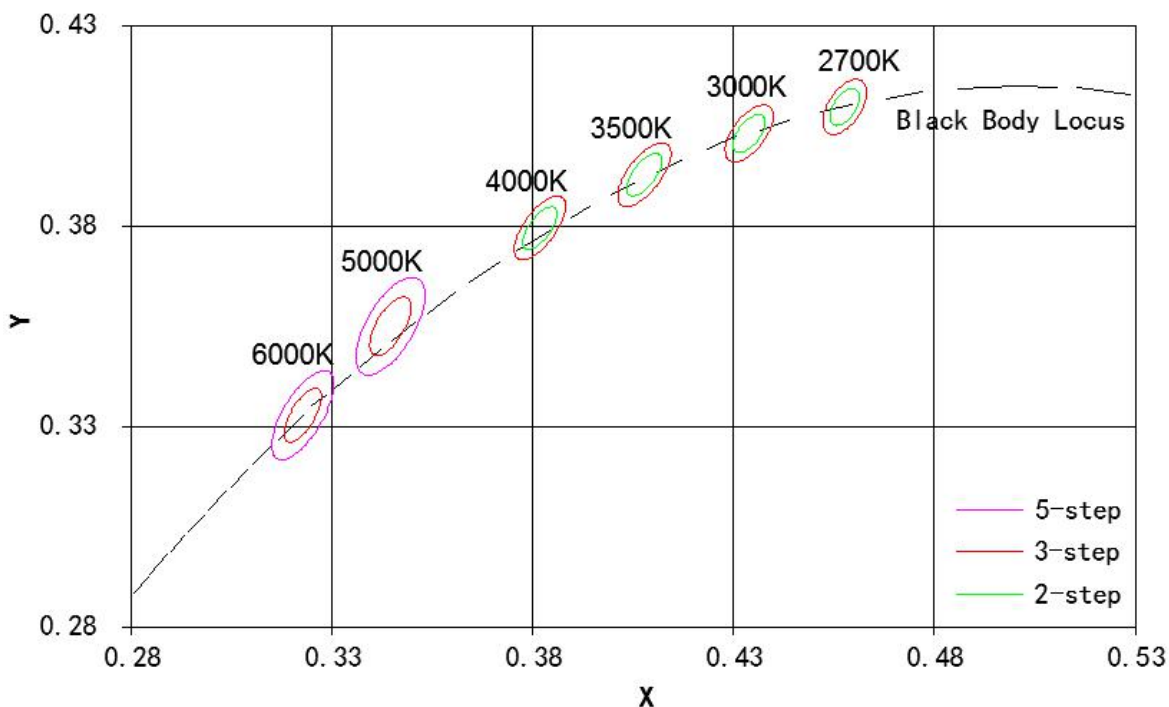

Note : Xuan Cai Electronics maintains chromaticity (x, y) +/-0.005.

6、Characteristic Curves 特性曲线图

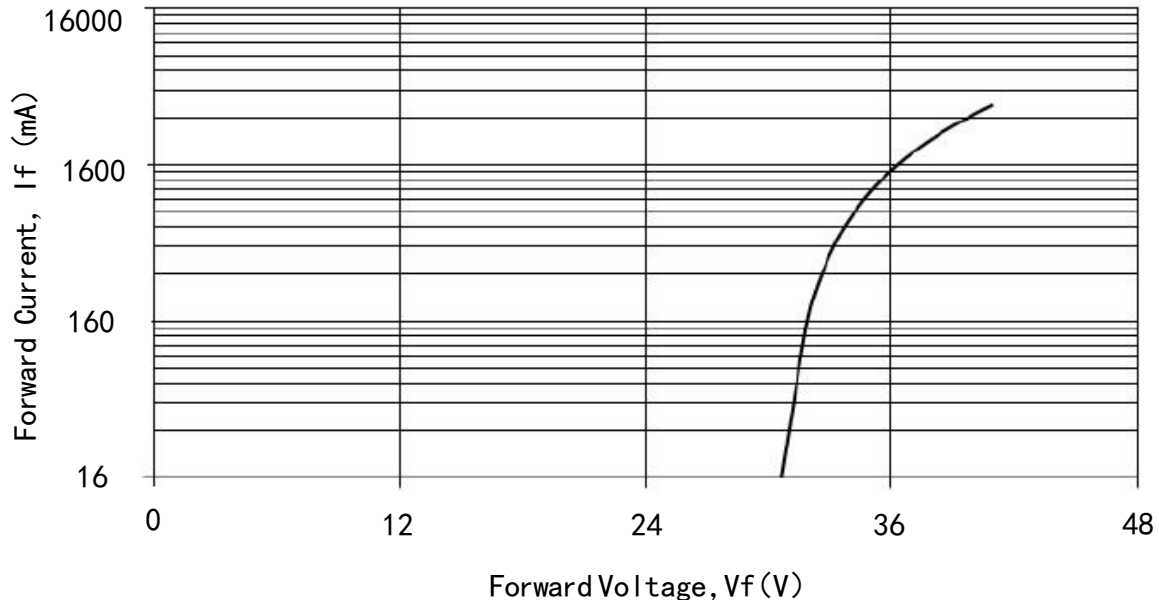

Forward Current vs. Forward Voltage (Tc=25°C)

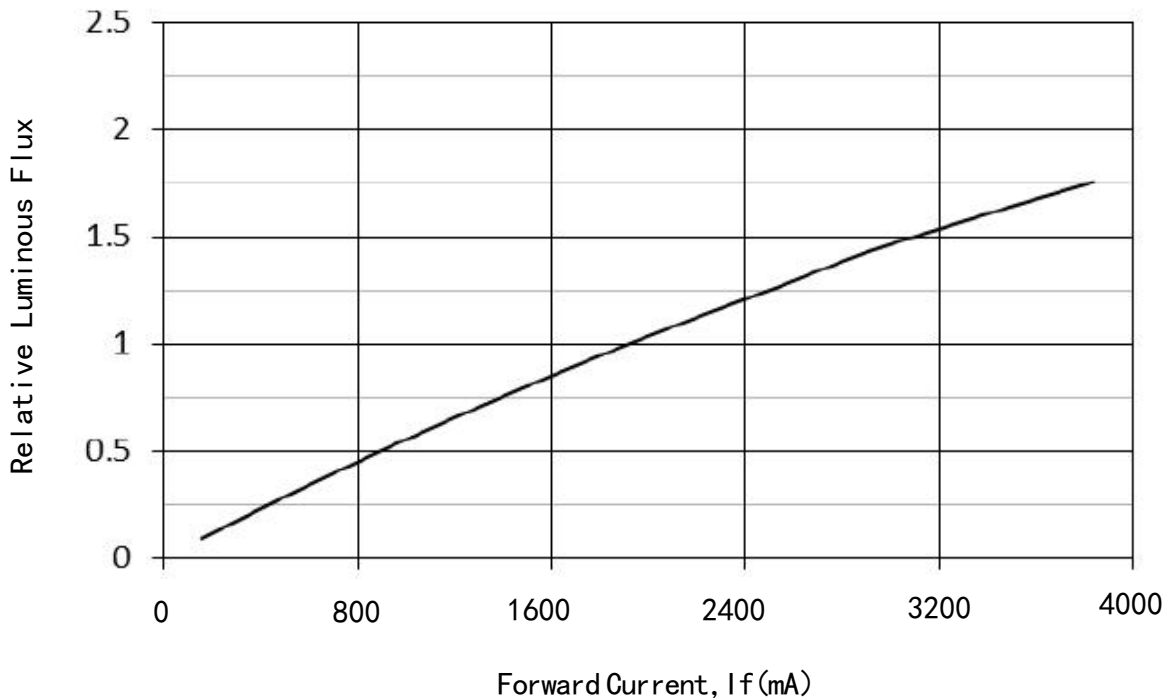

Forward Current vs. Relative Luminous Flux (Tc=25°C)

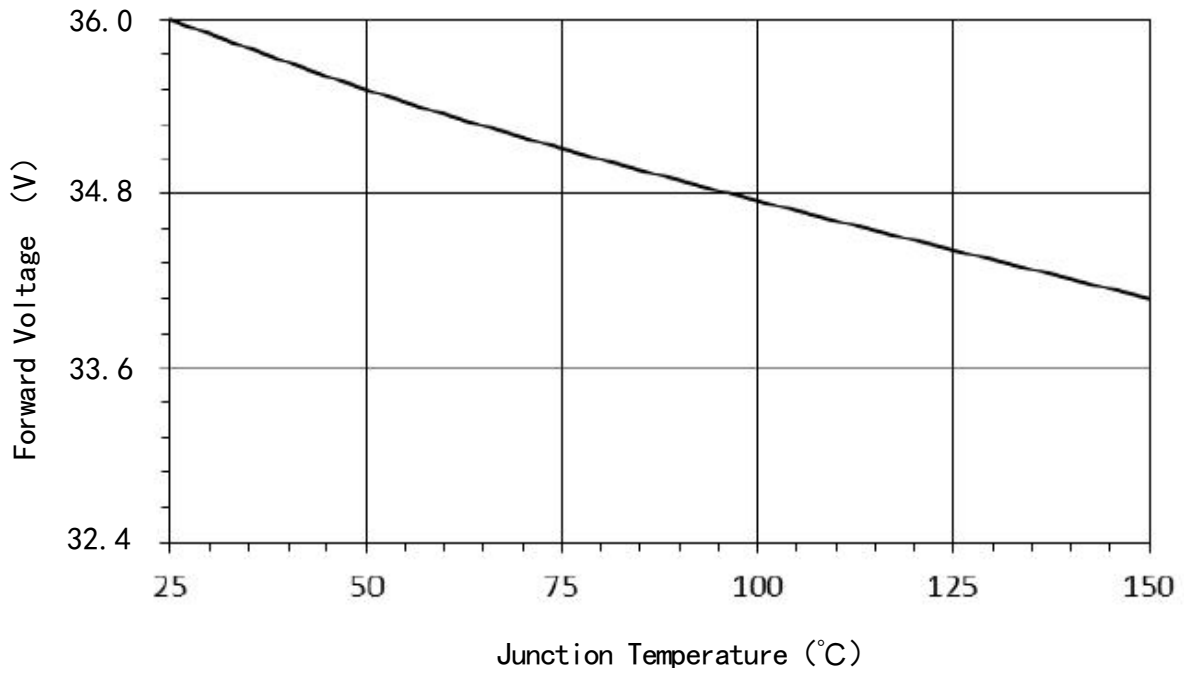

Forward Current Shift vs. Junction Temperature

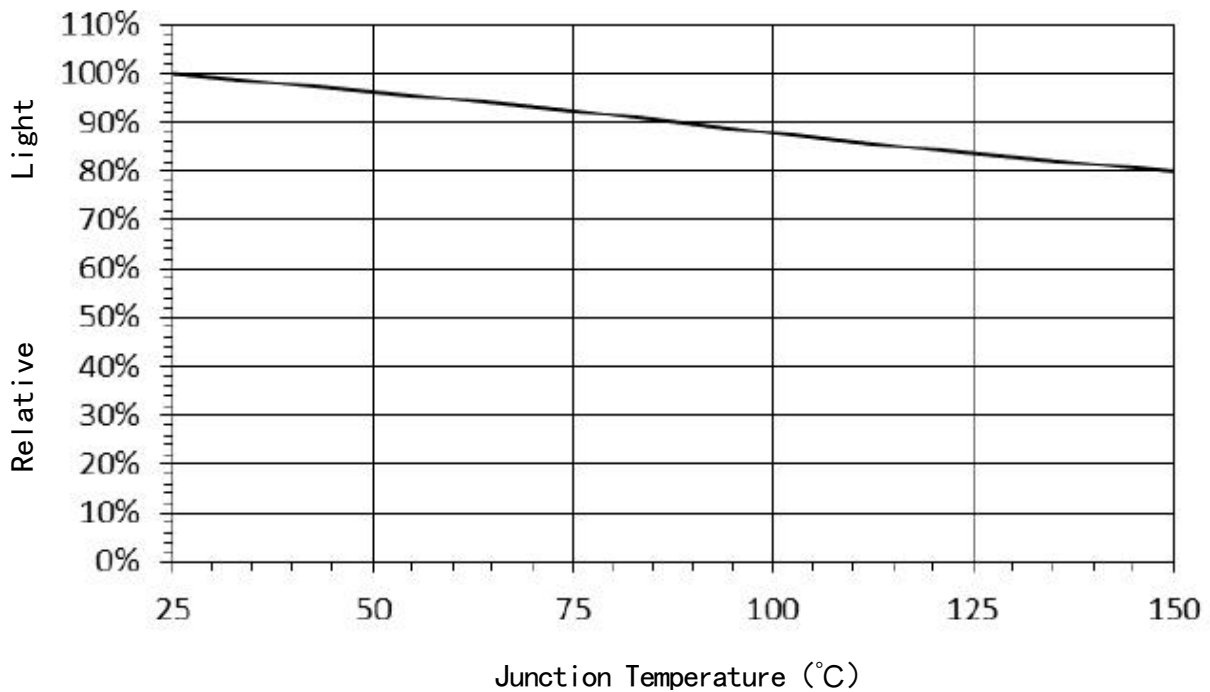

Relative Light Intensity vs. Junction Temperature

7、Mechanical Dimensions 产品外观尺寸

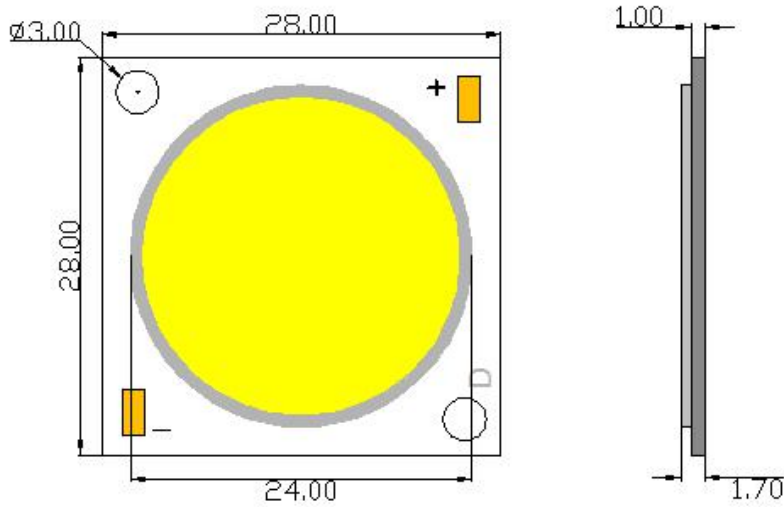

Unit:mm

Tolerances unless otherwise specified:±0.3

• Internal Circui

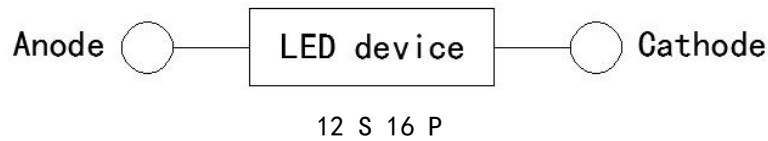

8、Reliability Test 可靠性测试

| No. 序号 | Test Item 测试项目 | Test Condition 测试条件 | Test Cycle 测试周期 |
|-----------|---|------------------------------|--------------------|
| 1 | Continuous Operation Test 光通量维持率 | Tc=85°C IF=2400mA | 1000H |
| 2 | Low/High Temperature Storage Test 冷热冲击 | -40°C/30min~ +100°C/30min | 100 Cycles |
| 3 | High Temperature Storage Test 高温存储测试 | Ta=100°C | 1000H |
| 4 | Low Temperature Storage Test 低温存储测试 | Ta=-40°C | 1000H |
| 5 | Moisture-proof Test 防潮测试 | Tc=60°C , 95%RH | 1000H |

9、Failure Criteria 失效判定标准

| Measuring Items 项目 | Symbol 符号 | Measuring Conditions 测试条件 | Failure Criteria 失效标准 |
|----------------------------|--------------|------------------------------|--------------------------|
| Total Luminous Flux 光通量 | Φ_v | IF=2400mA | $<S*0.7$ |
| Forward Voltage 正向电压 | VF | IF=2400mA | $>U*1.1$ |

U defines the upper limit of the specified characteristics. S defines the initial value.

Note :

Measurement shall be taken between 2 hours and 24 hours, and the test pieces should be return to the normal ambient conditions after the completion of each test.

10、User Manuel 使用手册

1. Storage 储存

To avoid moisture, we recommend storage conditions for the unopened LED +5 ~ +30°C relative humidity <60%. LED should be used within 168 Hrs. of opening the package. Please make sure to dehumidify and vacuum pack the remaining/ unused LED. Dehumidifying condition: +120°C±5°C of 4Hrs. Effective age for the sealed led is one year.

为避免受潮的影响，我司建议产品在未开包装前储存条件为 5-30°C，相对湿度小于 60%。已开包装的 LED 光源请在 168H 内使用安装完毕，如未用完之产品，请进行除湿并抽真空后密封保存。除湿条件：120°C±5°C/4H，产品密封保存有效使用期为一年。

2. The soldering precautions 组装注意事项

Soldering conditions: Reflow soldering is not recommended for this LED. If hand soldering, set sol-dering iron temperature at 350°C and soldering time not More than 3.5 seconds, after the first soldering, make sure the substrate surface temperature returns to ambient temperature before a second soldering. Please. make sure when soldering, there is no external force on the soldering surface and silicon batardeau (such as pressure, friction or sharp metal nails, etc.), to avoid gold wire deformation or dam-age and other abnormalities. If beyond recommended conditions, we cannot guarantee the LED stability, please do the risk assessment first. During assembly, please ensure that a good quality thermal paste is applied and distributed evenly over the surface. While using thermal pad (Heat Sink), make sure LED is firmly tightened and there is no gap between surfaces. In such heat-media products, through a pressure test of at least 500 volts.

焊接条件：此产品不推荐使用回流焊接的作业方式，手工焊接烙铁温度设定 350°C，焊接时间不可超过 3.5 秒，第一焊点焊接后请确保基板表面温度恢复到环境温度，方可进行第二次的焊接。焊接时

请注意不可有外力作用于胶体表面及外圈的围堰胶上（如压力，摩擦或锋利金属钉等），以免造成金线变形或断线等异常；如果超出此使用条件，将不能保证产品的稳定性，如需使用超出的操作条件，请务必进行风险评估。为确保在组装时降低接触热阻，请注意导热膏涂布均匀且分布面积均匀，不可出现导热膏太少或涂抹高低不平等现象。如使用导热胶垫时，请确保螺丝安装后基板与导热胶垫的完全接触，不可存在中空现象。产品在此类耐热介质下，能通过至少500伏的耐压测试。

3. Anti-Static Measures 防静电措施

Please take adequate measures to prevent electrostatic generation, such as wearing electrostatic ring or anti-static fingerstall etc; any relative products like plant equipment, machinery, carrier and transportation units shall be connected to discharging unit/ ground. The ESD sensitivity of this product is $> 1000V$ (HBM), after assembly the final lamp, please make sure to discharge Static Electricity by proper ESD equipment.

请采取足够的措施来防止静电产生，比如带静电环或防静电手指套等；每个制造厂关于产品（工厂、设备、机器、载波机和运输单位）应当连接到底面，请避免产品电气带电；本产品的防静电敏感度超过 $1000V$ (HBM)，装配后的最终灯具产品（S）建议检查是否损坏LED（漏电现象）。

4. Temperature Control 温度控制

Recommended temperature conditions for enhanced product life: Be sure to TS point (negative pads) controlled below $85^{\circ}C$, COB recommendation colloid surface temperature control $\leq 150^{\circ}C$.

保证散热前提条件为：请务必将TS点（负极焊盘）控制在 $85^{\circ}C$ 以下，建议COB胶体表面温度控制 $\leq 150^{\circ}C$ 。

5. The drive control 驱动控制

Drive this product at constant current. Output current range specifications should be according to the operational and other conditions, as mentioned in data sheet. Before using a constant voltage source or altered specifications other than recommended, please consider risk factors.

本产品需使用恒流电源进行驱动，且输出电流符合规格书上的使用范围，如需使用恒压电源或其他使用条件，请进行使用效果风险评估。

6. Eye Safety 眼睛安全

-The International Electrical Commission (IEC) published in 2006 IEC 62471

" 2006 Photobiological safety of lamps and lamp systems " which includes LEDs within its scope.

When sorting single LEDs according to IEC 62471, almost all white LEDs can be classified as belonging to either Exempt Group (no hazard) or Risk Group 1 (low risk).

-国际电子委员会 (iec) 于2006年公布“2006年灯具和灯具系统的光生物学安全”包括在其范围内的leds。在根据iec 62471对单个led进行分类时，几乎所有的白色led都可以归类为属于豁免组别（无危害）或风险组别1（低风险）

-However, Optical characteristics of LEDs such as radiant flux, spectrum and light distribution are factors that affect the risk group determination of the LED, and especially a high-power LED, that emits light containing blue wavelengths, might have properties equivalent to those of Risk Group 2 (moderate risk).

-然而，发光二极管的光学特性，如辐射通量、光谱和光分布，是影响led的风险群确定的因素，特别是高功率led，它发出的光含有蓝色波长，可能具有相当于风险组2（中等风险）的性质。

-Great care should be taken when directly viewing an LED that is driven at high current, has multiple uses as a module or when focusing the light with optical instruments, as these actions might greatly increase the hazard to your eyes.

-当直接观察在高电流下驱动的led，作为模块有多种用途时，或者当用光学仪器聚焦光线时，应该非常小心，因为这些动作可能会大大增加你眼睛的危险。

-It is recommended to regard the evaluation of stand-alone LED packages as a reference and to evaluate your final product.

-建议将独立的led软件包的评估作为参考，并对您的最终产品进行评估。

7. Other 其他

Should the product be used outdoors, be sure to IP (protection class) ≥ 65

若本产品户外使用，请务必保证IP(防护等级) ≥ 65

Product is not suitable to use in following conditions

本产品不可在以下条件下使用，如果产品在以下条件下使用，评估使用效果和风险是有必要的：

-Direct or indirect wet / damp conditions, such as rain, etc. ;

-直接或间接的打湿或受潮，比如淋雨等；

-In contact with sea water and erosive materials

-被海水损害或侵蚀；

-Exposed to corrosive gases (e.g., Cl₂, H₂S, NH₃, SO_x, NO_x, etc.);

-被暴露于腐蚀性气体(如 Cl₂, H₂S、NH₃、SO_x、NO_x等)；

-Exposed to dust, liquids or oils.

-被暴露于粉尘、液体或油。